

LAVATHERM 330 electronic

Tumble Dryer

Operating Instructions

Hello

Allow me to introduce myself: I am the tumble dryer LAVATHERM from AEG. From now on, I should like to make tumble drying more fun for you, not only because of my attractive appearance, but also thanks to my »intrinsic qualities«. I use very little energy, take great care of your laundry and I am very quiet in operation, easy to use and look after.

You must read these instructions prior to using the appliance and retain them for future reference.



Contents

Safety instructions	
Before first use	4
For the user	4/5
You should also note the following	5/6
Out of concern for the environment...	7
Important recommendations for drying	8/9
Appliance description	10/11
Before starting to dry	12
How to tumble dry correctly	12
Loading the laundry	
Open loading door	13
Loading laundry	13
Adding or removing laundry	13
Selecting the drying programme	
Programme selector	14
The push buttons and their functions	14/15
Programme charts	16/17
Cooling phase and automatic anti-crease programme	18
Programme end	
Switching off the appliance	18
Cleaning the fluff filter	18
Cleaning, care and maintenance	19
If you think your machine is not operating properly	19
Optional extras	20
Service	20
Technical Data	21

Safety instructions

Before first use

- It must stand on a firm and level base. My 4 adjustable feet allow for small height adjustments to compensate for uneven floor conditions. To adjust my feet insert a screwdriver into the vertical slots visible at the front.
- Wipe my drum with a damp cloth.
- I must not be sited in areas which may be affected by frost as the reliability of the electronic components will be adversely affected by sub-zero temperatures.
- The door can be hinged on the left or the right. Re-hinging of the door has to be carried out by an AEG Service Engineer or by an AEG appointed Service Agent.
- If you have to site me next to a gas, coal or electric cooker due to space problems, you have to place a heat insulating board (dimensions 85 x 57.5 cm) between me and the cooker. The side facing the cooker should be covered with aluminium foil.

Safety instructions for the user

AEG electrical appliance conform to the recognised safety regulations governing electrical domestic appliances. As a manufacturer, we nonetheless feel obliged to familiarise you and any other persons using the machine with the following instructions:

- To ensure safe operation I must only be operated according to the operating instructions.
- Please make sure before using your machine for the first time that the mains voltage and supply indicated on my rating plate agrees with the mains voltage where the machine is to be used. The fuse required is indicated on the rating plate.
- I am a domestic tumble dryer suitable for drying the usual household laundry. Check with the care labels in the laundry whether the manufacturer of the garment recommends tumble drying.
- Only dry laundry which has been washed in water and has been spin-dried.
- Before cleaning, care and maintenance work, make sure that the appliance is switched off. We advise for safety reasons that you pull the mains plug out of the socket, switch off at the power point or completely remove the fuse in the fuse box serving this circuit.
- Keep my surrounding area free from fluff.
- Never direct a water jet onto my outer casing!
- Never use my supply lead to pull the mains plug out of the socket!
- Never operate me if:
 - My mains supply lead is damaged, or
 - I show visible damage to the control panel, worktop or plinth.
- **Repairs to electrical appliances must only be carried out by trained electricians. Improper repairs may place the user at serious risk.**

- We recommend that repairs to AEG appliances should only be carried out by AEG service engineers or by AEG appointed service agents. This way you ensure that AEG spare parts are used which fulfil all the necessary requirements.
- If I am installed under a worktop in your kitchen or utility room, i.e. my worktop has been removed, an earthed cover plate must be fitted as access protection according to the Build-under installation instructions.
- Do not lean or sit on the open loading door – risk of machine tipping over.
- Children cannot recognise dangers when tampering with electrical appliances. Therefore, ensure proper supervision when appliances are in use.
- After drying has been completed, always close the loading door to prevent children or pets climbing into the drum.
- My exhaust air must not be vented into a chimney flue. My exhaust air must not be ducted into shafts which serve as ventilation shafts of heated areas.
Avoid sitting me in areas where coal, oil or gas burning stoves are discharging into a chimney flue and where the depression is 0.04 mbar and more.
Ensure sufficient ventilation of the installation area to prevent depression.
- When the day finally comes to withdraw me from service and to replace me with another machine, please make sure that you deactivate my door lock and cut off my electrical supply lead, disposing of lead and plug safely. This will prevent children from locking themselves in and endangering their lives. Then ensure environment-friendly disposal.
- If I am incorrectly operated or used for any purpose other than that for which I am intended, AEG cannot assume liability for any possible damage.
- Do not use me to stand on.
- During drying my rear panel will get hot. This is normal. Take care and do not touch.

- Please keep my packaging away from children. The foil represents a particular danger. Dispose of this material as quickly as possible. You will find details of the type of packaging materials used and how to dispose of these correctly in the literature accompanying the machine.
- Only dry in the tumble dryer articles which have been washed in water. **Do not** dry articles which have been cleaned in inflammable liquids, e.g. dry cleaning fluids or stain removers (benzine, alcohol etc.).
- Do not dry articles containing foam rubber or rubber-like materials in the tumble dryer (risk of fire).

**You should also
note the
following**

- Garments which contain residue of hairspray, nail varnish remover, hair styling agents. etc. must not be dried in the tumble dryer
 - risk of gas formation.
- Fabric conditioner sheets leave some residue on the fluff filter of the machine and they may actually block the filter. We would recommend that you use liquid fabric conditioner as part of the wash cycle rather than the conditioner sheets, if you want to use conditioner at all.
- Laundry which is dried in a tumble dryer is fluffy and soft and for environmental reasons you may decide not to use fabric conditioner.
- If you are using perfume-free or ecologically sound washing agents without perfume you may find that your laundry is not smelling as fresh as it used to. These are textile odours which have not been neutralised or covered by the perfumes normally found in washing detergents.
- Make sure that no garments are trapped in my loading door, otherwise damage will occur to the article.
- I can only start to work when my door is closed. When the door is open a safety switch prevents me from operating.
- If you are surprised by the amount of fluff in my filter after the drying cycle let me assure you that I **do not** subject your laundry to a lot of wear and tear. Fluff collected in my filter is due to you using and wearing your laundry and some due to washing in a washing machine. I only create 0.03 g of fluff per 1 kg of laundry.
- Do not use descalers containing acid, chlorine or ferrous substances or even soap filled pads to clean my stainless steel drum. AEG Service stocks appropriate cleaners for this purpose.
- Do not use furniture polish or abrasive cleaning agents on my control panel and controls. Wipe with soft cloth and lukewarm water only.

Out of concern for the environment

All tumble dryers require energy to dry. I operate very economically if you bear the following information in mind:

■ Select the correct spin to extract max. amount of water

I save a lot of energy when the **laundry** has been **spun** at **minimum 800 rpm**. Higher spin speeds extract even more water, shortening the drying times and reducing energy consumption.

■ Good ventilation in the laundry room

The temperature in the room where the tumble dryer is located should **not exceed 35 C** to ensure the most economical operating conditions.

■ The loads should have the correct weight

The most economical way to dry is to keep to the **recommended weights** in the programme charts. The following may help you to assemble the right load more easily:

Laundry weight:

Guide values for cotton (dry weight)

Bathrobe	1200 g
Overall	300-600 g
Duvet cover	700 g
Sheet	500 g
Blouse	100 g
Towel	200 g
Tea towel	100 g
Shirt	200 g
Pillow case	200 g
Nightdress/pyjama	200-500 g
Tablecloth	200-250 g
Underwear	250 g

■ Clean the fluff filter

My fluff filter must be cleaned after each drying cycle. A fluffed up filter requires longer drying times and thus more energy.

The packaging material meets ecological requirements and can be easily disposed of or can be burned safely in the municipal incinerators.

To the materials: the plastics can be recycled and are marked as follows:

> **PE** < for Polyethylene, e.g. the outer wrapping and the bags inside.

> **PS** < for blown (CFC free) Polystyrene, e.g. the fillers

The cardboard parts have been manufactured from recycled material and should be taken for recycling again.

Information on the packaging material of the appliance

Important recommendations for drying

Wool and down-filled articles

Do not dry any wool or wool mixtures – these fabrics will felt. Down-filled articles such as eider-downs should not be dried in a tumble dryer unless recommended by the manufacturer of the article. Linen should only be dried in the tumble dryer if the manufacturer of the article recommends this, tumble drying tends to make the surface of the article rough.

Textile care labels

Check whether the manufacturer of the garment has recommended tumble drying on the care label in the garment. You will find the following symbols in the garments.



May be tumble dried



Can be tumble dried on high heat setting



Tumble dry on low heat setting



Do not tumble dry

Laundry which has been marked with the symbol  is not suitable for drying in a tumble dryer.

Special care programme/ S-button

Heat sensitive materials such as acrylics with care label  are recommended to be dried in the Special care programme (press button S).

Creasing

Easy-care fabrics tend to crease when over-dried. We recommend to use programme 7.

The fuller the drum the more creasing will occur. We recommend to reduce the load to 1.5 kg or less for minimum iron fabrics particularly those which are large or light in weight. For loads below 1.5 kg we recommend that you use a time controlled drying cycle as the electronic sensor cannot accurately sense small loads.

Knitted cotton

These garments tend to shrink during tumble drying, remember this when buying new articles and choose size accordingly. Take care not to over-dry these garments and do not choose the programme "extra-dry". Shrinkage should however be minimal if good quality garments are chosen.

Starched laundry

Starched laundry can also be tumble dried. To achieve the starched effect use double the dose of starch. Wipe my drum with a damp cloth after drying to remove any starch residues.

Spin laundry before tumble drying

Spin your laundry well before tumble drying. We recommend at least 800 rpm. Higher spin speeds will reduce the drying times and the energy consumption. For easy-care fabrics choose the special spin which you will find on your washing machine for these fabrics.

Close zips and any buttons and tie loose apron strings etc. to prevent laundry from tangling.

Turn double layered garments such as anoraks inside out to get a more even drying result.

Do not dry new dark coloured garments together with light coloured ones to prevent discolouration of garments.

Preparing the laundry

Appliance description

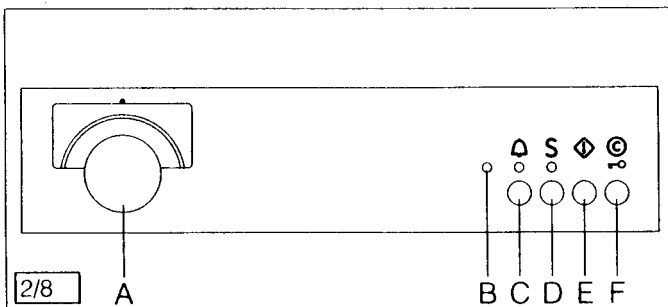

Features

- A** Programme selector
- B** Machine "ON" light
- C** Accoustic "programme end" indicator
- D** Button for special care programme
- E** Start button
- F** Door release/cancel button (for any depressed buttons)

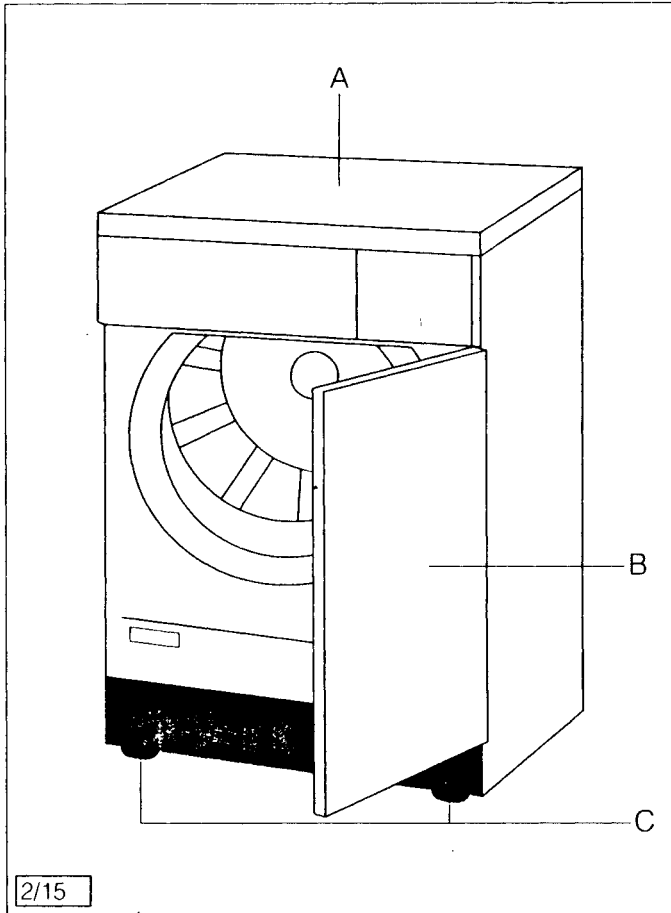

A Removable worktop

B Appliance door is opened by pressing door release button (when machine is connected to electricity) or by using override

C 4 height adjustable feet (front and rear)

Features

Before starting to dry

Sorting the laundry

Sort your laundry as follows:

- cottons and linens
- easy-care fabrics
- dark coloured laundry
- light coloured laundry

Check that the laundry is recommended for tumble drying.

Due to felting do not dry any woollen garments, wool mixtures, hand-knitted wool garments or any garments which incorporate a proportion of wool.

Prepare garments for tumble drying

Empty pockets

Remove any metal articles from laundry, e.g. paper clips, safety pins, coins etc.)

Close all buttons, zips, hooks and eyes. Tie loose belts and apron strings.

How to tumble dry correctly (Brief instructions)

What to do before drying

1. Sort the laundry
2. Select the drying time
3. Open loading door
4. Loosen laundry and place in drum
5. Close the loading door
6. Select option buttons
7. Press start button

At the end of programme

8. Open the loading door
9. Remove the laundry
10. Switch off the appliance
11. Clean the fluff filter
12. Close the loading door

Loading the laundry

There are two ways of opening my loading door:

1. Press the door release button

To open my door this way I have to be connected to the electrical supply. This means, the machine has to be plugged in, socket switched on and the programme selector has to be moved from the off (0) position. My machine "on" lamp lights up.

2. Override

If I am not connected to the electrical supply (e.g. my machine "on" light is **off**), press my door half-way up on the left-hand side to open.

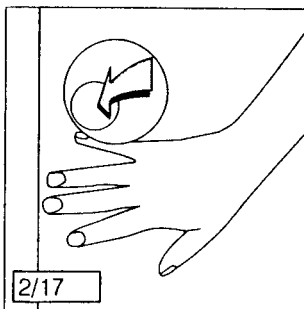

You can use this method of opening the door any time you want regardless of whether the machine is connected to the electrical supply.

Loosen the laundry before loading into the tumble dryer. This will cut down on drying times and reduce creasing due to tangling. If you keep to the recommended weights for the different loads this ensures economical operation. But do not overfill the dryer, this will increase the drying, the energy consumption and result in excessive creasing.

You can open the loading door at any time during the programme to add or remove laundry. To open the door press the Cancel/Door release button or use the Override.

Take care when adding or removing laundry

The inside of my drum and the laundry may be hot – so do take care when adding or removing laundry during a drying cycle.

Before you re-start the machine you have to **re-select the Option buttons (Special care button or acoustic programme end signal)** as they will have been cancelled when the door was opened. This does not apply if you use the Override to open the door. Close the loading door and press the Start button and the drying cycle will continue.

Opening the loading door

Loading the machine

Adding and removing of laundry

Selecting the drying programme

Drying time selector

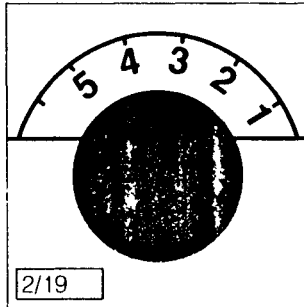

My programme selector can be turned clockwise to any setting. It has 3 functions:

- The programme selector switches me and the machine "on" light on and off.
- You use the programme selector to set the drying programme required. Consult the programme chart as to which programme you should choose.
- The programme selector switches my light inside the drum on and off.

The buttons and their functions

By combining the main programmes on the programme selector with the available buttons I offer maximum programming flexibility.

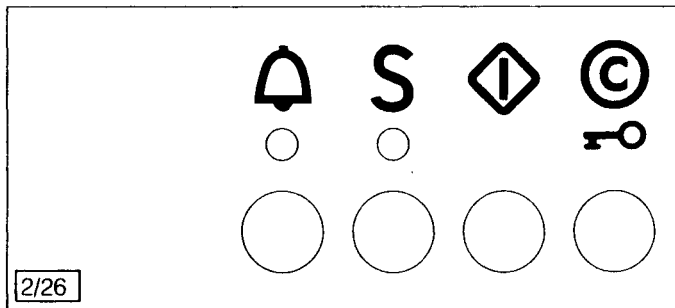

A red indicator appears above the depressed button.

For this button to function you need to connect me to the electrical supply and turn my programme selector to a setting. The machine "on" lamp lights up. Now press the door release button to open my loading door.

If I am not connected to the electrical supply, press my door half way up on the left-hand side and the door springs open. If the door is hinged on the left-hand side then press the door on the right-hand side.

If you press my door release button during a drying cycle, the drum stops rotating when the door springs open. At the same time **any depressed buttons are cancelled**. This does not apply if the door has been opened using the Override.

To continue the programme re-select the buttons required and press the Start button.

To cancel any depressed buttons, press the Cancel/Door release button. The loading door automatically springs open.

Press this button to start the programme.

When you press this button the drying temperature is reduced. You can dry delicate fabrics such as acrylics or other delicate fabrics which bear the care label . Due to the lower heat the drying times are somewhat longer. Selecting the S-button is only economical for loads of 1 – 2 kg. For this reason we only recommend the use of this button for programmes 6, 7 and 8 (see programme chart).

Press this button if you wish the programme end to be indicated by an acoustic signal. The signal can be heard intermittently for 30 minutes. During this period my drum rotates intermittently (see automatic anti-crease cycle).

Cancel/Door release button



Start button



Special care button







Acoustic end-of-programme button





Programme Chart

Brief programme instructions are found on the front of the machine.

Programmes for cottons/linens (capacity up to 5 kg)

Progr.- Number	Degree of Dryness	Symbols	Type of Laundry/ Fabric
1	Extra Dry		Heavy weight or multi-layered textiles
2	Cupboard Dry		Textiles medium weight, articles not made up of multi-layers
3	Very slightly damp		Lightweight materials requiring ironing
4	Ironing damp		Normal cotton and linen articles
5	To be ironed by rotary ironer		Cotton and linen articles, to be ironed by rotary ironer or starched laundry

Programmes for easycare fabrics: cotton/polyester mixtures and synthetics (capacity 1 – 2 kg)

Progr.- Number	Degree of Dryness	Symbols	Type of Laundry/ Fabric
6	Extra Dry		Heavy and multi-layered textiles
7	Cupboard Dry		Lightweight materials which do not require ironing
8	Slightly damp		Lightweight synthetics and cotton/polyester mixtures requiring ironing

Information for Test Institutes:

For the test according to DIN 44986 the following programme selections should be used:

Programme A (5.0 kg) Programme Selection 2
 Programme B (5.0 kg) Programme Selection 4
 Programme C (1.5 kg) Programme Selection 7

Airing Programme

Programme Selection 

You can use this programme to air textiles or to tumble out slight surface creasing. Slightly damp the creases and tumbling in cold air will help to smooth out the creases.

Laundry Examples	Use S-Button	Electrical Consumpt. (kWh)*	Time in Min.*
Towelling material, bath robes	No		
Towelling garments, cotton bed linen, kitchen towels, cotton underwear	No	3.2	75
Cotton shirt and underwear	No		
Sheets and pillowcases, tablecloths	No	2.5	60
Cotton sheets and pillow cases, tablecloth	No		

* Values refer to 5 kg cotton laundry which has been spun at 800 rpm.

Laundry Examples	Use S-Button	Electrical Consumpt. (kWh)*	Time in Min.**
Sweatshirts, bed linen and table linen	Yes		
Easycare fabric shirts, table linen, baby clothes, socks and underwear	Yes	0.7	20
Bed and table linen, easycare fabric shirts and blouses	yes		

** The values refer to 1.5 kg laundry which has been spun in the easycare fabric spin programme of the washing machine.

Drying by time

You can select a drying time between 20 and 60 minutes for small loads under 1 kg or indeed for single garments.

If a particular programme does not give you the result you require choose another programme number. Laundry will get progressively dryer the lower the programme number chosen.

Cooling phase and anti-crease cycle

Shortly before the programme finishes the laundry is cooled down. If the laundry is not removed at the end of the programme the anti-crease cycle commences automatically. It lasts for 30 minutes and the drum rotates intermittently. This ensures the laundry remains loose and fluffy and does not pick up any creasing. At the end of the anti-crease cycle the programme switches off automatically and the laundry should really be taken from the machine at this point to prevent creasing.

Programme end

Turn the programme selector to the 0 (off) position. The interior light and the machine "on" light will go out.

Switching off the appliance

Cleaning the fluff filter

Fluff collects in the fluff filter on the inside of the loading door. (The amount of fluff breaks down as follows according to HEA, Frankfurt, the main advisory body for electrical appliances: (70% due to wear, 20% due to washing and 10% due to tumble drying). To ensure unimpeded airflow it is necessary to clean my fluff filter after each drying cycle. To clean the filter lift up the coarse filter and remove fluff from fine filter.

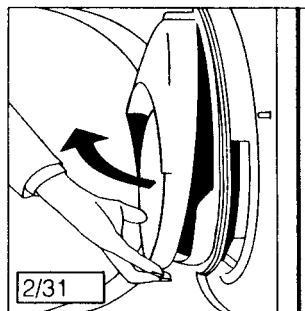

Fluff is more easily removed if you damp your hand slightly or use a damp cloth. After cleaning the fine filter, fold down and clip in coarse filter.

Cleaning, Care and Maintenance

If the required degree of dampness or dryness is no longer reached, e. g. the laundry is either too dry or too damp an almost invisible film may have formed on the inside of the drum and the electronic sensors are unable to sense accurately. Clean the inside of the drum and the lifters with a cloth and vinegar.

Controls and control panel must not be cleaned with any furniture polish, household cleaners or abrasive cleaning materials. Should cleaning be necessary use warm water and a soft cloth.

Cleaning the drum

Cleaning of the controls and control panel

If you think your machine is not working properly...

... the appliance is not working

- Has the plug been inserted into the socket?
- Have you selected a programme?
- Have you pressed the start button?
- Have you closed the loading door?
- Is the fuse in working order?

... the drying result is unsatisfactory

- Have you selected the correct programme?
- Have you cleaned the fluff filter?
- Have you used the recommended weight for the programme?
- Has the laundry been spun sufficiently to extract water?
- Has a hardly visible film formed on the drum interior or the lifters?

... the drum illumination does not work?

- Has the plug been inserted into the socket?
- Have you turned the programme selector from the 0 (off) position?
- Is the bulb still in operational order or is it due for replacement?
Use only 10 W replacement bulbs available from AEG Spare Parts Department under product number ET-No. 647 078970.

Optional Extras

The following items can be obtained as optional extras through your AEG stockist:

Stacking kit to stand Lavatherm tumble dryer on Lavamat washing machine

You can combine me with a LAVAMAT washing machine of the current or the previous range to make a space saving washer/dryer combination by using one of the two available stacking kits:

1. Stacking kit with pull-out shelf to rest your laundry basket E-No. 607 899 966
2. Stacking kit without pull-out shelf E-Nr. 607 899 969

Building under a continuous worktop

You can build me under a continuous worktop either with my own worktop in place or you can remove my existing worktop. In this case you must fit an earthed cover plate available from AEG Spare Parts Department under the product number ET-No. 647 405 423.

Service

We would like to point out that repairs are not free of charge during the warranty period if they are due to a user error, misuse or abuse of the appliance or if advice contained in our literature accompanying the machine has not been followed (see also our warranty conditions).

If you do not find any information in this booklet as to how to rectify a fault please contact AEG Service quoting the E-No. and the F-No. of the appliance which can be found on the rating plate.

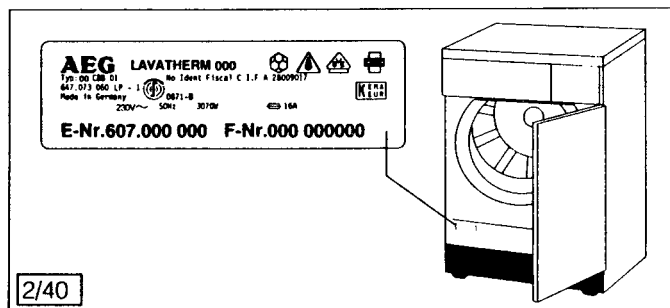

These numbers enable the Service Department to prepare as far as possible any spare parts required to rectify the fault on first call. This may save you money.

Transfer the E-No. and the F-No. into the space provided below for easy reference.

E-No.

F-No.

Technical Data

Dimensions

With worktop:

Height: 85.0 cm

Width: 60.0 cm

Depth: 60.0 cm

Without worktop:

Height: 82.0 cm

Width: 59.5 cm

Depth: 57.0 cm

Connection

Information relating to electrical connection is given on the rating plate and in this booklet in the relevant section.

Please ensure that the voltage and current indicated on the rating plate agrees with the voltage of your electricity supply.

Capacity

Depending on the programme chosen: up to 5 kg

Electricity consumption: 5 kg cotton spun at 800 rpm

programme cupboard dry 3.2 kWh

Adjustable height

+ 1 cm / - 0.4 cm

Depth with door open: 116.5 cm

Weight: 43 kg

Suitable for: domestic use

Ambient temperatures: + 5 ° C to + 35 ° C

The appliance is radio-interference suppressed in accordance with EN 55014 DIN VDE 0875 part 1, EC Directive 82/499 EC, 87/308 EC as well as the Standard relating to the Retroactive Effect of the Mains Supply EN 60555 part 1 – 3/DIN VDE 0838 part 1 – 3, June 1987.

AEG Hausgeräte AG
Postfach 1036
D-8500 Nürnberg 1

© Copyright by AEG

H 244272840 – 04911./26 –

AEG Domestic Appliances Ltd

Customer Care Department

55-77 High Street

Slough

Berkshire SL1 1DZ

Telephone: 08705 350350